

Products and concepts for  
**Buses**

**Mobility** | Making mobility happen.



# CONTENTS

<b>Mobility. Materials. Photonics.</b>	
United by passion	4
<b>Mobility</b>	
Making mobility happen	6
Moving into the future	8
Once an idea – Today, the standard	10
From start to finish	12
<b>Products for buses</b>	
▪ We build 1.60 meters of the bus	14
▪ Complete systems for articulated buses	16
▪ Folding bellows	20
▪ Energy guidance systems	22
▪ The right articulation system for every bus	26
▪ Driving safety & comfort	28
▪ tram2BRT – Steering technology for innovative vehicle concepts	30
▪ The double-pitch articulation HDNG	32
▪ Concept consultation	34
▪ Hydropneumatic chassis and wheel guidance systems	36
▪ Elastomer solutions	38
▪ Insulating materials and sound absorption	40
▪ FRP components	42
▪ Ramps & lifts	44
<b>Service</b>	
Service – Check!	46
<b>The company</b>	
HÜBNER worldwide	48



HÜBNER Group  
**Mobility. Materials. Photonics.**  
united by passion.

Since the beginning in 1946 when Kurt Hübner founded the company, HÜBNER has been shaped by a spirit of enterprise, inventiveness and innovation. Today it continues to be this same passion for new solutions that drives the company and its employees. Again and again over the years, new concepts for new products and new markets have been developed and implemented.

It is on this basis that HÜBNER has become the company that it is today: A comprehensive system supplier for transportation technology and the worldwide leader for gangway systems (Mobility), a well-recognized specialist for sophisticated elastomer solutions and products, insulation and composite materials (Material Solutions), as well as an up-and-coming company in the field of laser, terahertz and high frequency technologies (Photonics).

Today the HÜBNER Group consists of more than 30 different companies and has more than 3,300 employees around the world. And HÜBNER products continue to stand out with their high-quality workmanship, their superior convenience and their distinctive durability. This high level of quality is to be found in all of the Group's business sectors and throughout the entire product range.

This all comes together in our company slogan:  
**Mobility. Materials. Photonics. | united by passion.**







## Mobility | Making mobility happen.

Hardly anything in today's globalized society shapes life as much as mobility. In addition to data and goods, it is people who are on the move more than ever before. As the global leader for gangway systems and a major supplier of bus, rail and airport technology solutions, the HÜBNER Group plays an integral part in this megatrend.

For decades, the company has been delivering innovative products for the transport sector. The extensive portfolio ranges from customized gangway systems, to chassis technology, to driver displays in locomotive cabs and other vehicles, to products for airport technology applications.

With increasing mobility, however, there is also growing demand for protection of the environment and resources. HÜBNER innovations such as lightweight articulation systems or aerodynamically streamlined corrugated bellows for railway vehicles are making significant contributions to greater energy efficiency in public transportation – while at the same time allowing for higher speeds.

And the materials used in HÜBNER products – many developed specifically for these applications – feature outstanding durability, thus reducing the consumption of resources over the whole product life cycle. HÜBNER has been developing innovative mobility concepts and solutions around the world for decades. These are making mobility happen today and are opening up new mobility horizons for the future.





## Moving into the future

A terrific team: Bus technology and the name HÜBNER have been joined together for decades. In transport systems around the world. Wherever people are traveling by bus, HÜBNER products are there providing key functionality – connecting, sealing, cushioning or protecting as required. Whether vehicles are conventionally powered, with CNG or electricity – HÜBNER delivers reliability that hits the mark.

HÜBNER's transport industry products are distinguished by their precision and dependability. They have been demonstrating their quality in daily use for decades – on streets and roadways around the world. In addition to delivering the highest quality, it is HÜBNER's consistent customer focus that makes it a first choice worldwide.

Harmonized production processes and techniques at all HÜBNER manufacturing locations around the world guarantee uniformly high standards. Always with the aim of using company expertise to achieve the very best result for the customer. Ideas are made ready for serial production on the basis of customer specifications or products are customized to precisely fit each customer's needs. New developments such as double-pitch articulation systems and products for multi-element vehicles are extending the HÜBNER portfolio in the mobility sector. And existing electronic systems such as the articulation control unit ACU are always being further developed and enhanced – because safety has the highest priority. Taking a future-oriented approach, we are meeting the challenge of ISO 26262.

### Good connections to customers

When he opened a repair shop for rubber products in 1946, Kurt Hübner took the first step on the way to the establishment of the international HÜBNER Group of today. Since this time, inventiveness and a drive to innovation have been part of the DNA of the family-owned company. More than 3,300 highly qualified employees around the world are at work every day meeting diverse requirements and developing new solutions. The close and effective cooperation between employees and customers is a key part of the company's success. HÜBNER reacts speedily and individually in response to customer wishes – one of a range of factors resulting in the many close and long-term partnerships HÜBNER has with producers as well as with end customers.

### A global knowledge network

The know-how present in the company has grown over decades. Through the company's involvement in diverse industries and countries, a wide range of technological approaches and expertise are today available for implementation. Customers place their trust in this knowledge and come to the company's engineers with challenges of many different sorts.

Close contacts are key. That's why the family-owned company follows its customers into diverse sales markets. The company is represented on all five continents and in all the world's growth regions. In addition to the company headquarters in Kassel, Germany in center of Europe, HÜBNER has also established major locations in Hungary, Brazil, Russia, China and the USA as well as production facilities in India, Malaysia and South Africa. These locations are supported by sales partners and trade representatives in more than 30 additional countries.



## History

# Yesterday an idea, today the standard

Again and again, HÜBNER has been a driving force for technological progress. Moving from an idea to a product ready for the market: From the beginning, the family-owned company has made a clear commitment to innovation and outstanding quality in its products and concepts.

With the design and production of gangway systems for buses and railway vehicles, HÜBNER is the recognized global leader. HÜBNER developments form the basis for many bus products that have become standard in the market – from folding bellows made of rubber-coated fabric, to quick-change window systems, to the first redundant articulation damping system and the new articulation family HNGK 19.5, which stands out with its distinctively lightweight design.

The HÜBNER Group is active today around the world and is working continually to develop new products and solutions with its cross-industry know-how – always in close proximity to customers and their needs. In this way the company continues to set new standards for the future.





## From start to finish

### Customized solutions

Whether it's components, complete systems or full series: HÜBNER delivers customized solutions for every sort of need. Customers benefit from the HÜBNER employees' many years of experience – in development and production as well as in project management. Production standards that are uniform around the world guarantee precision products and consistently high quality.

### Always up to standard

HÜBNER products meet all established international standards and requirements – as documented by numerous certifications. And often HÜBNER products exceed these standards in their functionality or safety aspects. This is the case, for example, for the requirements for preventive fire safety standards in materials and components.

### Setting out on new ways

Innovation has a tradition at HÜBNER. That means to always be enhancing products, to be thinking ahead and setting out on new ways with new ideas. The in-house departments for research and development are continually working on improvements, including on innovative folding bellows materials. There is also ongoing testing of new materials with optimized fire safety standards and higher environmental compatibility. Partnerships with leading scientific institutes support knowledge transfer and the inclusion of the latest technological developments. Product enhancements and innovations are always designed to benefit the customer – or their customers. For example with color design. Now it's possible to integrate the vehicle gangways into the overall optical design of the connected bus segments. Another new trend is the use of translucent bellows materials. These let sunlight come into the bus gangways, creating a new and more friendly atmosphere.



Image courtesy of Irizar e-mobility



## We build **1.60 meters of the bus**

Without HÜBNER, articulated buses would be missing something – exactly 1.60 meters right in the middle of the bus! 1.60 meters equipped with the latest technology and engineering solutions. HÜBNER provides complete, ready-to-install connection systems for all types of articulated and bi-articulated buses in low-floor and high-floor models. These systems include the articulation system, the folding bellows, the energy guidance system, electronic articulation control and components for the bus interior.





## Complete systems for articulated buses

The HÜBNER Group has a comprehensive range of ready-to-install systems for articulated buses. These integrated systems fulfill all requirements in low-floor and high-floor segments of articulated buses. Pre-assembled and delivered just-in-time, these systems allow for simple and economical assembly at the customer's facilities.

Our product range includes all components that are used in the connecting segment of articulated buses. The technology and design of all these components is perfectly coordinated, and they can be used with a multitude of different drive concepts and floor heights.

### The HÜBNER way

At HÜBNER, products are always being enhanced and developed further. For the realization of our future-oriented products we only use materials of the highest quality, often developed in our own laboratories. This allows us to meet the combined demands of faultless functionality, top safety and outstanding durability. Our many years of worldwide experience together with exacting quality requirements are the basis for our pioneering product development – in manufacturing and in servicing solutions. All this stands behind our success story – for more than 70 years HÜBNER has been a sure source of reliable and safe products for passenger transportation.







## Components of the complete system

### Folding bellows – Robust, flexible and customized as required

HÜBNER has been producing folding bellows for articulated buses since 1952. Thanks to this unique depth of experience and expertise, the company's products are distinguished by their outstanding UV stability and tear and abrasion resistance. In addition to its commitment to quality, HÜBNER is devoted to continual development and enhancement of all components. On this basis, customers benefit from improved utility and expanding possibilities. Special covering elements also facilitate the installation of energy guidance components. Folding bellows can be produced in customized colors and even in translucent models – we're setting new accents in vehicle design.

### Energy guidance systems that fit for every situation

Whether in the articulation segment, on the side of the vehicle, in the roof or even outside the vehicle: HÜBNER energy guidance systems can be integrated into the gangway segment in many different ways. The layout of the cabling and other characteristics of the system are always adjusted to the requirements of the vehicle and the wishes of the customer. All HÜBNER energy guidance systems have one thing in common: They are optimally protected against damage and they're designed to handle the entire range of vehicle movements – for the long term and with minimal wear and tear.

### Articulation systems for every application

The articulations support optimal maneuverability and nonetheless keep the bus perfectly on track in every situation. Articulation systems can do more than just hold the individual segments of the bus together. The HGNK 19.5 family of universal articulation systems, for example, provides the benefits of low-weight construction together with high damping torque. The compact articulation HNG 24.2 is particularly resistant to dirt and soiling. The heavy-duty articulation HNG 15.3 handles loads up to 4.5 tons. HÜBNER articulation systems – for a safe and secure connection.





## Folding bellows

HÜBNER folding bellows are made with specially coated fabrics and have a stable aluminum frame. All folding bellows are produced on a customized basis – exactly fitted to the vehicle type and vehicle design. In this way, folding bellows models of all different sorts can be provided in accordance with customer requirements.

### Outstanding material characteristics

Depending on the place of use, folding bellows fabrics can also be equipped with additional characteristics such as enhanced UV stability, resistance to heat and cold, high tear resistance as well as abrasion resistance. This gives customers outstandingly adaptable and resilient folding bellows. Because durability and quality are hallmarks of the HÜBNER Group.

### Going green with new high-grade materials

HÜBNER is committed to improving the protection of human health and the environment through the use of the best possible chemicals in its production processes. This is in keeping with the REACH program of the European Union. Fabrics for folding bellows shall comply with upcoming international regulations to prevent restricted materials – named in blacklists or red-lists of several OEMs. These regulations will restrict the use of chemical halogens in fabric coatings, for example.

### Colored or translucent designs

Optically there are almost no limits in the look folding bellows can have. In addition to the standard gray model, HÜBNER also manufactures special design folding bellows according to customer wishes – making for articulated buses that have their own special look. The folding bellows are available in single or multi-color designs. For example, the color of folding bellows can be perfectly coordinated with other features of the vehicle design. Or special designs with original motifs and graphic elements can be prepared for advertising purposes or to celebrate special occasions. The folding bellows becomes an eye-catcher – and the bus becomes a design event.

HÜBNER also can supply translucent folding bellows made of BrilliantFlex® materials. The benefit: In the bus interior, the articulation segment, which often tends to be dark, is instead brightened by daylight shining through the translucent material. This makes for a friendly atmosphere in the bus and contributes to passengers' feeling of safety.

### Coverings for energy guidance systems

Specially developed coverings make it possible to lay energy guidance systems in the floor, sides or roof area of the folding bellows. The coverings separate and protect these lines from the interior passenger area of the bus. Depending on the vehicle model, HÜBNER offers a multitude of cover possibilities that perfectly combine design and technical requirements. In addition to the classic interior design solutions, the company's experts also develop and produce special roof and hood coverings.

### Products for special applications

HÜBNER also produces flexible folding bellows solutions for special vehicles of various sorts. These folding bellows fulfill customer-specific wishes for special forms and models with particular insulation properties for high or low temperatures as well as solutions with stricter fire safety standards that are oriented to requirements in the railway sector.



## On the move with **electric power**

Electromobility isn't only a trend in the area of private transport. More and more public buses also are powered by electricity and are thus helping to protect our climate and resources. HÜBNER is actively supporting these developments. The company has extended its innovative range of energy guidance systems for different types of articulated buses with a new packet for electric, hybrid and trolley buses. This way power is brought to exactly the point where it is needed in the vehicle.





## Energy guidance

Routing cables and hoses from the front vehicle segment to the back segment is a particular challenge with articulated buses. Cables and hosing need to move as the vehicle moves but must not under any circumstances kink or break. To achieve the best possible functionality and durability, energy guidance systems from HÜBNER are specifically configured for each customer and integrated into the structure of the vehicle. The focus is on tested quality: On request, each connection packet can be examined on a test rig before being put into operation.

### Perfect coordination

Whether it has to do with the number and dimensions of the lines or their stiffness and configuration – all characteristics are customized to fit the needs of the customer and to coordinate perfectly with one another. This ensures that cable systems keep up with all the movements of the bus, and that wear and tear in the flexible lines is kept to a minimum.

### Energy guidance in the articulation segment

With the Universal Articulation and the Compact Articulation, the hose and cable lines can be conducted comfortably through the area of the articulation system without affecting the floor height of the vehicle. Lines with a diameter of up to 30 mm can be routed directly through the articulation itself.

### Energy guidance in the side sections

The energy guidance system in the side sections is suitable for both low-floor and high-floor buses. Cables, lines and coils are laid out so that they stay optimally positioned during each bend that the bus makes.

### Energy guidance in the roof area

For roof area systems, HÜBNER uses the proven energy guidance system in C-form. This type of cable routing ensures low-wear movements, avoiding extreme kinking of the lines. The optional bulkhead plates, which can be mounted on the front and rear vehicle segments, facilitate the installation of cable packets in the vehicle and create a clear interface.

### Energy guidance in the bus exterior – Our new S-EGS

For the e-mobility challenge, HÜBNER has developed its own energy guidance system for electric, hybrid and trolley buses. With the innovative new system, high-voltage lines, battery lines, potential compensation cables and lines for conducting liquids can be laid on the exterior of the vehicle.

The benefit: The relative movement of the lines to one another is minimized in this way, and wear resulting from exterior environmental factors is essentially eliminated. The lines can also be very well protected against UV and weather impacts.

Currently energy guidance packets with a total weight of up to 70 kg can be realized – with cables having an exterior diameter of up to 42 mm. There are various individual options for the optical design of the cable routing. For example, it can be covered laterally or through a complete folding bellows attachment and thus incorporated in the overall vehicle design.

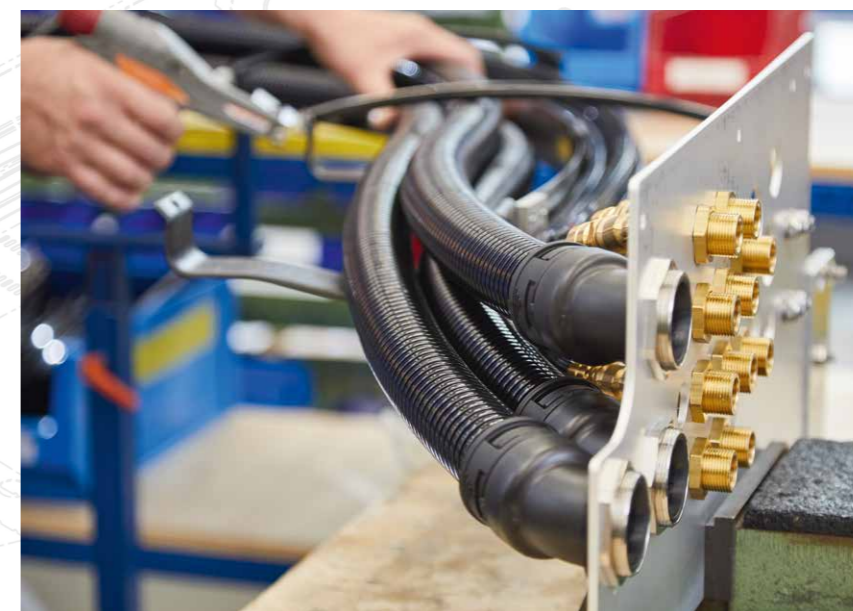
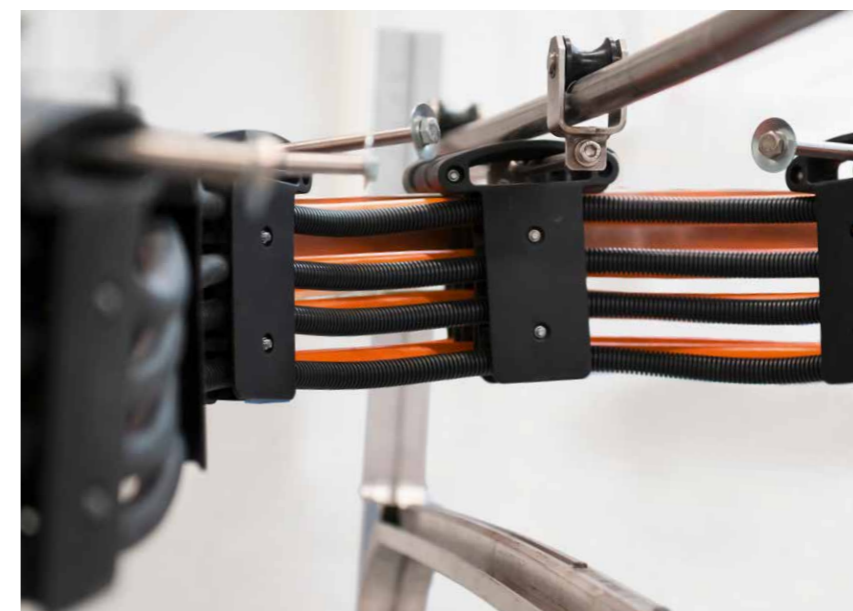
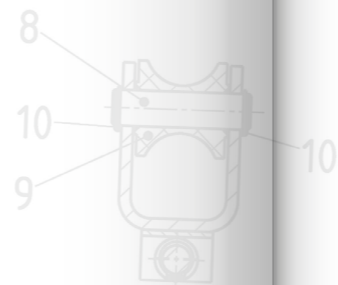



## The right articulation system for every bus

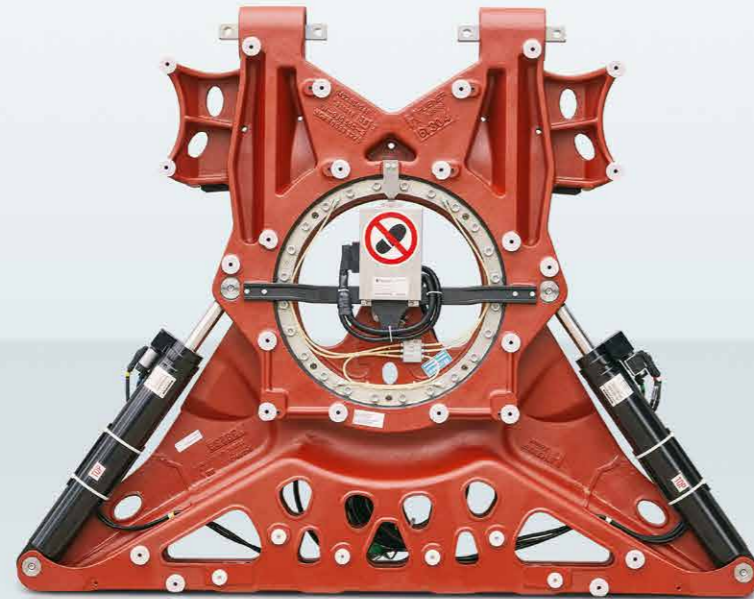

### Testing for top safety

Articulation systems from HÜBNER undergo particularly rigorous testing. All system components are subjected to extreme loads on specially developed test rigs. In addition, endurance limit testing is conducted in cooperation with well-known universities and testing laboratories. The articulation system designs are based on FEM (finite element method) calculations. Measurements taken under extreme operating conditions around the world serve as the basis for these calculations. Through the use of low-maintenance damping systems, the articulations are conceived for long service intervals. As always, HÜBNER's aim is to meet the highest quality standards in its products and in the service provided after sales.

### HNGK 19.5 – The universal articulation with two variants

The HNGK 19.5 is the most widely used universal articulation system. It has been developed into an articulation product family while retaining the existing interface connections. This has made it possible to combine the proven technology with a new lower weight articulation system. This is a significant advantage as the lighter components help to reduce energy use of the vehicle throughout its lifetime.

Customers can select between two articulation variants: The HNGK 19.5 "eco" provides a weight advantage of approximately 16 percent. The HNGK 19.5 "HD" (for heavy duty) is weight-optimized but at the same time can accommodate significantly higher forces.

#### HNGK 19.5 "eco"

- System weight 590 kg
- Axle load 25 kN

- Suitable for low-floor and high-floor buses
- Clearly defined connection surfaces
- High damping torque
- Elastic torsional connection
- Integrated energy guidance system
- Available in standard or deluxe versions

#### HNGK 19.5 "HD"

- System weight 650 kg
- Axle load 35 kN

\* Higher operating loads available on request



### HNG 15.3 – The heavy duty articulation

This heavy-duty articulation system provides the same functionality as the universal articulation systems, but has been specially developed for vehicles with higher axle loads. With this articulation, loads up to 4.5 tons can be handled without problem, as is sometimes the case with electric, hybrid, CNG or trolley buses. Particularly in North and South America, this articulation system finds frequent use.

#### HNG 15.3

- System weight: 590 kg (without rear vehicle connection)
- Axle load 45 kN
- Suitable for low-floor and high-floor buses
- Clearly defined connection surfaces
- High damping torque
- Elastic torsional connection

### Platform

The platform is available in various models and makes it possible for passengers to move comfortably between the different sections of the vehicle. It reliably absorbs all movements occurring while the vehicle is in operation. Depending on maintenance requirements, HÜBNER has just the right platform option for you.







## Driving safety & comfort

From mechanical damping systems to electronically controlled models with full diagnostic capabilities – HÜBNER develops and produces damping systems for all drive concepts and operating conditions.

### Low-maintenance functionality

All HÜBNER systems are low-maintenance and provide functionality that is unique in the industry. With redundant dampers or emergency damping, the products support a high level of safety for passengers and vehicles. Independent of the articulation system, customers can typically choose between standard and deluxe damping system options. With regular series production, it is also possible to switch between the two systems for different requirements through customization of the electrical vehicle interfaces.

### Optimized articulation control – ACU

HÜBNER delivers bus articulation systems with microprocessor-controlled electronics. The articulation control unit (ACU) automatically determines the current driving situation, communicates with the engine management system and sets the damping behavior at the appropriate level. To meet higher safety and convenience requirements, the control unit has been optimized once again. The new ACU.4 generation of articulation control units also includes an interface for external braking requirements (XBR).

### Individually adjustable

HÜBNER control units have simple and effective adjustment functionality. Virtually all customer wishes regarding driving behavior or vehicle electronics can be quickly and easily realized. Requirements regarding driving dynamics and safety can also be handled. HÜBNER makes use of its many years of experience in customizing articulation systems for all different types of vehicles to provide outstanding adjustment options.

### Comprehensive testing

Calculating. Simulating. Testing. For HÜBNER, comprehensive testing of individual products as well as of the complete vehicle is an integral part of the development and production process. Such testing is the basis of the company's unmatched safety and quality standards. Only through test runs is it possible to determine whether a product can stand up to the tough demands of daily operation. In many areas, HÜBNER components provide much more than the minimum official requirements necessary for authorization in the vehicle.



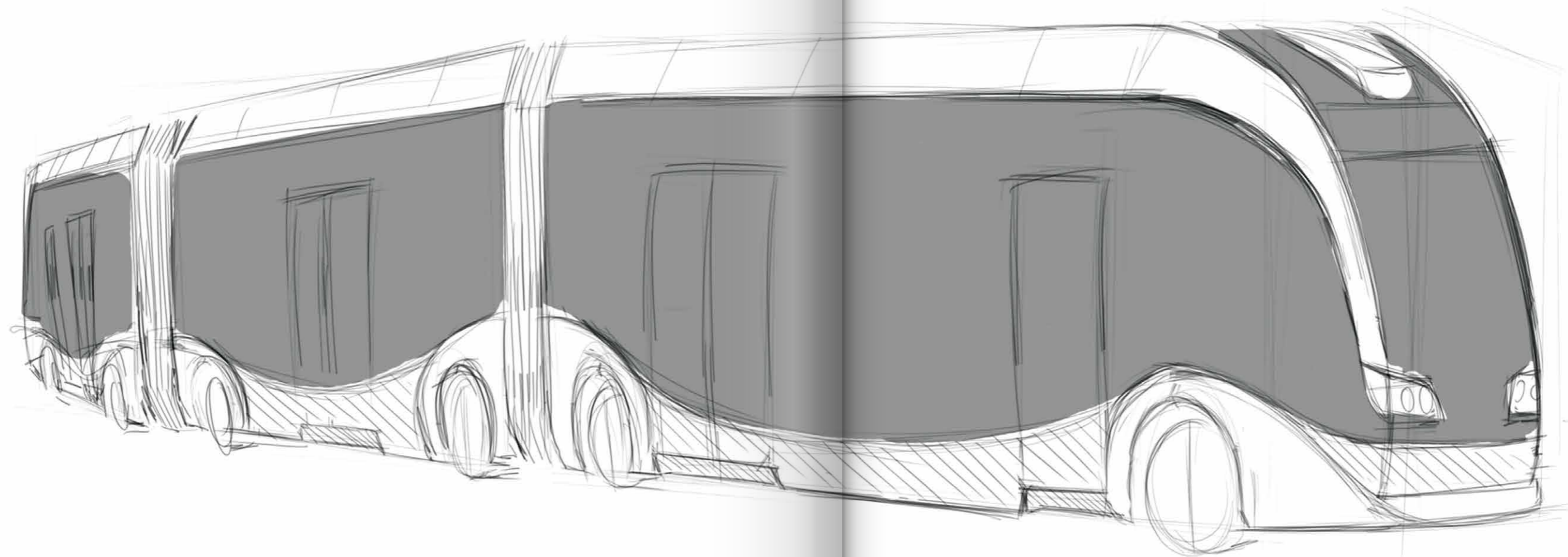

© Fraunhofer IVI

18

24

36

## tram2BRT – Steering technology for innovative vehicle concepts

Today public transport systems in many places around the world are reaching their capacity limits. Through population growth and centralization, giant metropolitan areas have come into existence. Traditional transport systems do not provide sufficient capacity to handle this growth, and creating new systems or developing the existing ones is enormously expensive. Environmental impacts that are continuously increasing also make it imperative that we find quick and effective measures to provide environmentally sound mobility.

**E-mobility is now opening up opportunities for a new vehicle concept to help meet such challenges – tram2BRT.**

Traditionally, buses and railway vehicles have shared the tasks of providing passenger transportation in metropolitan areas. Buses with more economical infrastructure and higher flexibility – railway vehicles with the advantages of environmental compatibility, greater convenience

and higher transport capacities. The trackless tram concept represents a combination of these system advantages. The realization and operation of street-based trackless trams (tram2BRT) is more economical and also more environmental than rail-based public transport.

The vehicles for a trackless tram concept are more than 30 meters long and consist of three vehicle segments each with two axles. With appropriate steering and control technology, the needed degrees of maneuverability and driving stability can be ensured. HÜBNER has developed a key component – lane guidance – for this purpose. Steering and gangway systems have been developed in accordance with relevant safety standards so that safe driving operation and the safety of passengers can be guaranteed. On this basis, HÜBNER is advising vehicle manufacturers on questions of vehicle development and is supplying all the necessary components for buses that feature the transport capacities of a tram.



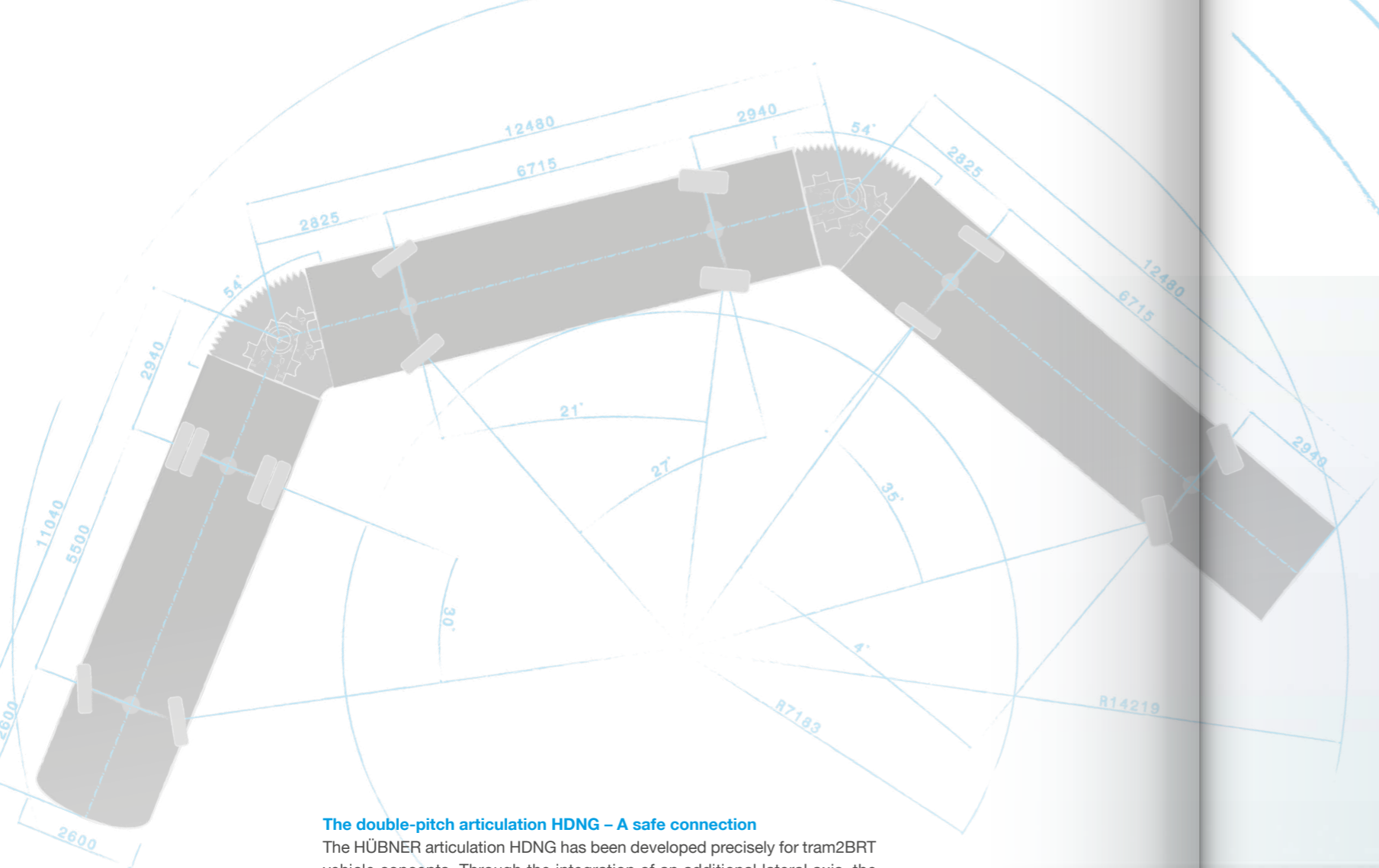

**The double-pitch articulation HDNG – A safe connection**

The HÜBNER articulation HDNG has been developed precisely for tram2BRT vehicle concepts. Through the integration of an additional lateral axis, the double-pitch articulation system makes it possible to connect double-axle vehicle segments. As with other articulated buses, passengers can move safely and comfortably between the vehicle segments. A special articulation sensor system and actuator ensures reliable communication with the steering system and provides for driving stability. This ensures that the movements of the articulation are optimally coordinated with those of the axles. The double-pitch articulation system is thus a key component and integral element of the HÜBNER steering technology – for the realization of buses with higher transport capacities.

**HDNG**

- System weight: 620 kg
- Length: 1800 mm
- Compatible with HÜBNER standard front car connection
- Suitable for low-floor and high-floor buses
- Clearly defined connection surfaces
- Elastic torsional connection
- Large bending angle
- Optional bending angle sensor system

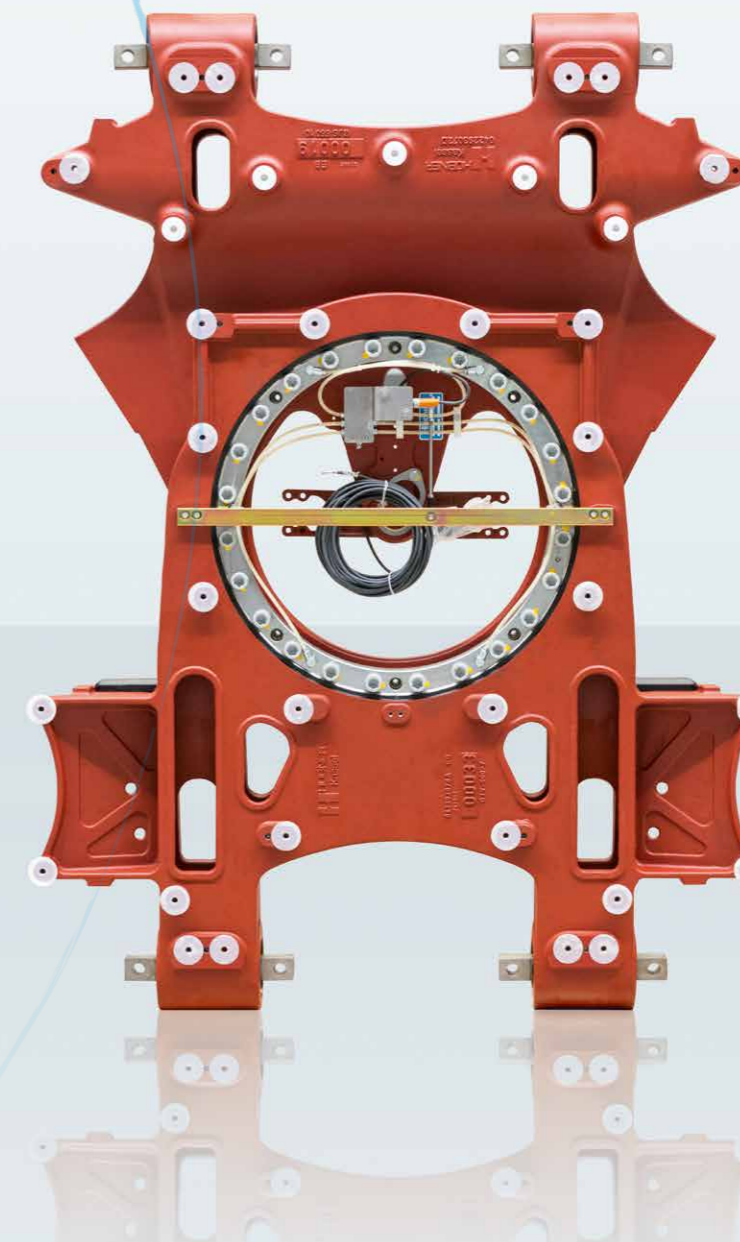



## Concept consultation

During the development of articulated buses, the design demands for implementing an optimal connection of the articulation to the chassis are exceedingly high. Working in close cooperation with customers, HÜBNER provides calculations and strength testing in connection with the overall integration process.

### Customized designs

We develop detailed FE models on the basis of your drawings. Then through a special calculation process, we evaluate the design together with you, filter out weak points and develop suggestions for improvement. It's your decision: HÜBNER advises you through multiple design stages up to the final creation of a connection design – as an individual part, component, or as a 3D model (CATIA V5).

### FEM calculations & strength testing

Together with you, HÜBNER determines the ideal connection of the articulation system to the chassis on the basis of load data and our

worldwide database. We model the design of the articulation connection in a 3D system specifically developed for this purpose. We represent your specific requirements for HÜBNER products precisely and realistically on the basis of FEM (Finite Element Method) calculations. Particular attention is paid to the analysis and documentation of the permissible loads.

### Test drives for stress analysis

To verify the computer-based calculations, HÜBNER makes use of test runs under real conditions. By subjecting the chassis to the relevant load cases, we can determine together with you how reliably our product is integrated with your chassis. At points of the connection that are subjected to particularly high stress, we attach sensors and compare these data with the results of the FEM calculation. With these sensors in place we then determine the real stresses that occur during test drives. This is your guarantee for the highest levels of quality and safety.







## Comfort and stability

As part of the HÜBNER Group, HEMSCHEIDT provides components to enhance comfort, stability and safety in buses, commercial vehicles and trains. These are robust and effective high-performance products. They feature low-weight designs and long and reliable product life cycles. For buses, HEMSCHEIDT develops and produces hydropneumatic chassis and wheel guidance systems.

### Safe and secure connections

HEMSCHEIDT products connect bus vehicle elements with one another to guarantee superior driving dynamics. To ensure optimal connection of axles with the vehicle platform, HEMSCHEIDT has developed a comprehensive guide kit that can be customized for specific customer requirements.

[www.hemscheidt.de](http://www.hemscheidt.de)





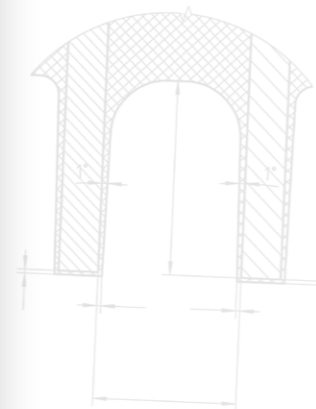
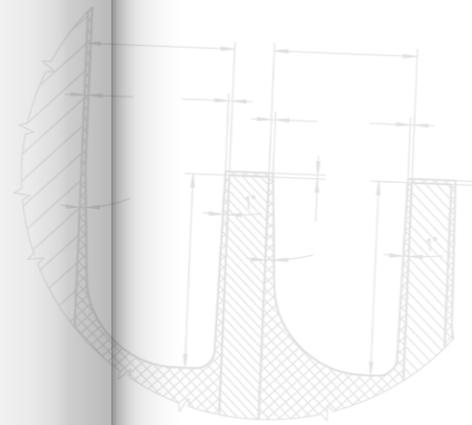

## Elastomer solutions Protection & sealing

Rubber and silicone products protect, absorb, seal and insulate – whether as delicate precision components or as seals weighing up to several kilograms. For decades, HÜBNER has been successfully processing rubber for the complete range of applications in bus construction. HÜBNER experts have approximately 600 different compound formulas at their disposal as they develop customized rubber-based solutions. The company's offerings range from consultation, to design, to production – from the prototype to regular serial production. Through the acquisition of the GWU Group in 2019, HÜBNER has now also significantly extended its expertise in the area of door safety sealing systems.

### Rubber & silicone molded parts and seals

HÜBNER is specialized in providing high-quality molded parts and profile seals. These in-house developed components can cover the full range of special requirements. The products are oil, heat and UV resistant and can be provided in virtually any color, shape or configuration. For applications requiring special levels of elasticity and resistance to cold and heat or particular electrical insulation properties, high-quality EPDM synthetic rubber or silicone can serve as a good basic material.

### Joining rubber and metal

Using high-performance metal pretreatment techniques, HÜBNER provides strong and stable connections of rubber with steel, aluminum, brass and other metals. These products play a central role in buses – for example as bracket elements, stops, rails, buffers and discs.

### Rubber profiles and frames

Rubber profiles are available featuring punched-out and cut-out sections, molded-on parts, shape-molded corners and preheated radial connections. The product range includes window sealing systems and frames, hatch seals, door and flap seals, suspension elements as well as elastic bearings to absorb harmful or disruptive vibrations. For corners that are subject to especially hard wear, through shearing effects for example, HÜBNER produces rubber frames with injection-molded corners. With this special production technique it is also possible to connect hollow chamber profiles and profiles of differing diameters with each other.

### Door profiles with passenger protection

Intelligent rubber profiles can provide added safety in public transport. Finger protection profiles with electrical contact strips prevent passengers from getting caught in closing doors – a focal point of development work at GWU. An innovative new rubber profile even functions on a touchless basis. With this system a light curtain detects when persons or objects are present in the closing area of the door. In addition, GWU has developed a door profile with LED light strips. It uses signaling colors to show passengers when it is safe to enter and leave the vehicle.



## Insulating materials and sound absorption **Making noise quieter**

Noise protection and insulation play an important role in ensuring passenger comfort and safety on buses. Plastocell specializes in developing and manufacturing products for this application area. Now part of the HÜBNER Group, the company has been developing solutions for sound insulation and thermal protection for more than 30 years. These products are put to use in many different parts of bus vehicles. They play vital roles in absorbing disturbing factors such as the noise and heat emissions of the motor.

Plastocell has decades of experience in the production and processing of various materials. Through the combination of foams, plastics and other materials, the company has developed effective damping and insulating products with a wide range of specific physical characteristics. Depending on the composition and the requirements of use, these products help to reduce mechanical, acoustic or thermal impacts in and around the vehicle. Particularly the sound insulation fixtures function not only for the benefit of vehicle occupants but for others as well. Noise exposure for nearby residents, other road users and the environment in general can be significantly reduced.

### Optimally insulated – From end to end

The rear end of the vehicle is a critical area for thermal emissions. Here a combined system featuring heavy-duty film and the polyester fleece Plastobond protects against noise and heat emissions. In the engine compartment, the flexible foam Plastotect serves to protect the passenger area of the vehicle against heat. At the same time, insulation in the engine compartment also reduces noise. Plastocell also supplies special insulating elements for the service cover, floor coverings, the ceiling and side panels of the bus. Highly flame-resistant heat and sound insulation can also help to provide pleasant temperatures and a low noise level in the driver's cockpit as well.

In addition to Plastocell's standard solutions, the company also develops user-friendly special models of its products. For all of the company's products, Plastocell delivers individual components that are optimally matched to one another and that meet all applicable fire-safety regulations for public transport – which are becoming increasingly strict.

[www.plastocell.de](http://www.plastocell.de)







## Fiber reinforced plastic – For high stress applications

The fiber composite FRP ( fiber reinforced plastic) is a versatile and economical material of high strength. For just this reason, it finds frequent use in the bus industry. Its non-susceptibility to corrosion is also a significant benefit for use in the mobility sector. FRP components are used, for example, in roof constructions in hybrid and CNG buses as well as for vehicle front and rear ends.

The GWU Group, which belongs to HÜBNER, supplies German and international vehicle manufacturers with FRP components and paneling systems that are individually and flexibly adjusted to specific customer wishes.

The company can provide product development, prototype and sample construction, mold and model making as well as the production and assembly of ready-to-install components.



Ramp & lifts

## Perfect access for every vehicle type

The entry systems from HÜBNER Transportation GmbH help to give handicapped persons greater mobility and freedom. Our ramps and lifts for buses fulfill the highest safety and quality standards. For nearly every type of vehicle, we can provide customized solutions – perfectly coordinated with the vehicle design in form and color.

### Manual and electric ramps

The manual ramp is a hand-operated solution to facilitate easy entry for handicapped persons into buses and trams. It can be integrated into the vehicle floor and can handle loads up to 500 kg. Customers can choose between various sizes and models. These include plastic-based products that allow for weight reductions.

The height difference between the curb and bus floor can be overcome with particular convenience using an electric ramp from HÜBNER Transportation GmbH. Designed for loads of up to 400 kg, the ramp can be deployed or retracted on a fully automatic basis with the push of a button. Its sensor system makes it possible for the bus driver to operate the ramp without leaving the driver cockpit. The electric ramps are available in various models. All of ramps feature non-slip surface coatings made of tough, highly durable materials.

### Manual and electric lift systems

The EXEO 400 lift system can handle loads up to 400 kg and is operated by remote control. Ergonomic lift railings provide optimal comfort and safety. All drive units are integrated in the lift itself making for quick and simple installation.

The “EXEO light” lift system features manual operation. This applies for the retraction and extension of the lift as well as for setting up the roll-stop and bridge plate. Nonetheless, the manual operation is simple and convenient. Because of the absence of an electric drive unit, the system is especially lightweight and enables economical retrofitting possibilities for buses.

Both lift systems are service-friendly and are suitable for use in both inter-city and touring buses.





## Service from A to Z

HÜBNER not only provides first class products. We also guarantee dependable operating performance and safety, also for years after purchase.

### Consulting

Our aim is that your vehicles maintain a high and consistent level of availability and reliable operation over many years. In this connection, our team will be glad to assist you with any issue, whether it involves the management of spare parts, performing repairs or individual training requirements.

### Spare parts

Nothing is better than the original. This is especially true for spare parts that have a critical influence on the function and safety of your vehicles. Our many years of experience in design, service and operations flow directly into our products, helping to ensure a high level of availability. We will be pleased to advise you regarding our assembly-optimized spare-part sets or our exchange program for major components of bus articulation systems.

### Inspections

The mix of varying external factors impacting on vehicles in different situations results in service intervals of differing lengths. In our inspections we provide a precise determination of the current status of your components. On the basis of this analysis, it is possible to provide service that fits the actual condition of your fleet, thereby increasing availability and at the same time reducing costs.

The following services can be provided:

- Evaluation of the condition of the components
- Checking of mechanical functions
- Inspection of the control unit (when present)
- Determination of repair and maintenance needs
- Documentation of component condition in a service report

### Training

It is important to have well-trained personnel so as to be able to react quickly and correctly to maintenance issues. Take advantage of our intensive, highly practical training programs or ask about our customized training offerings.

### Maintenance

If desired, we can take care of all of the maintenance work in connection with your bus articulation systems. Professional maintenance by HÜBNER technicians includes:

- Examination, adjustment and, if necessary, exchange of mechanical, electrical and hydraulic components
- Lubrication of all bearings
- Elimination of soiling
- Small repair jobs on folding bellows
- Documentation of the work performed in a comprehensive service report

If desired, training of your personnel can be conducted directly in conjunction with our maintenance work.

### Repairs

We offer economical repair work and servicing on site as well as factory-based repair of your HÜBNER vehicle components. Product refurbishments are also available to bring your vehicle components up to the latest technical standard.

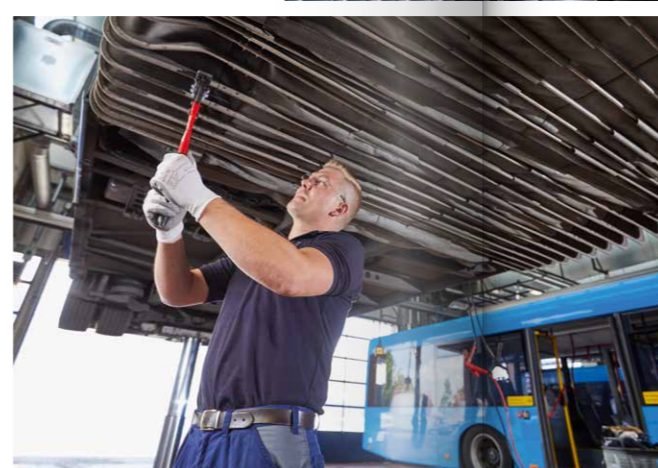
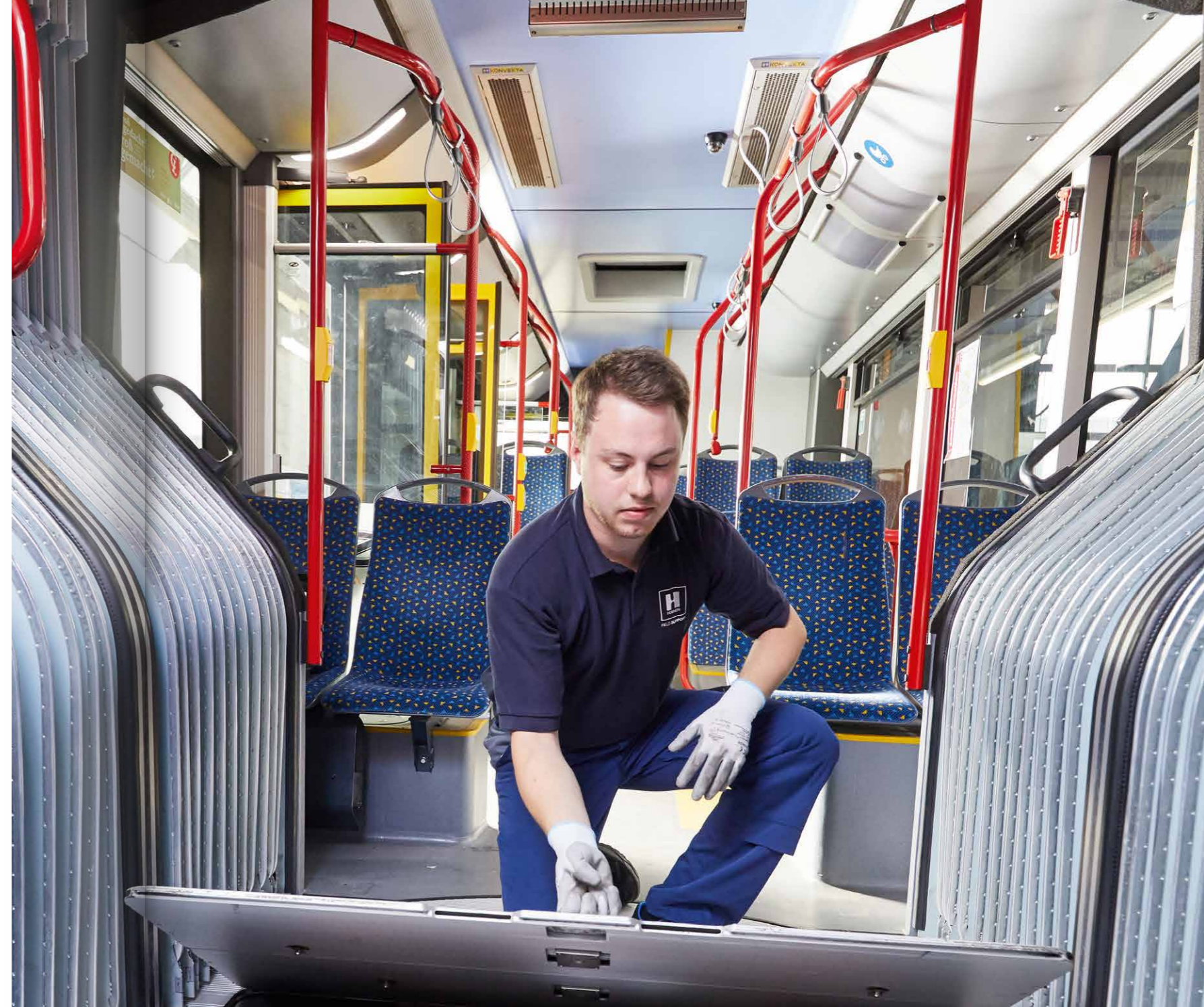



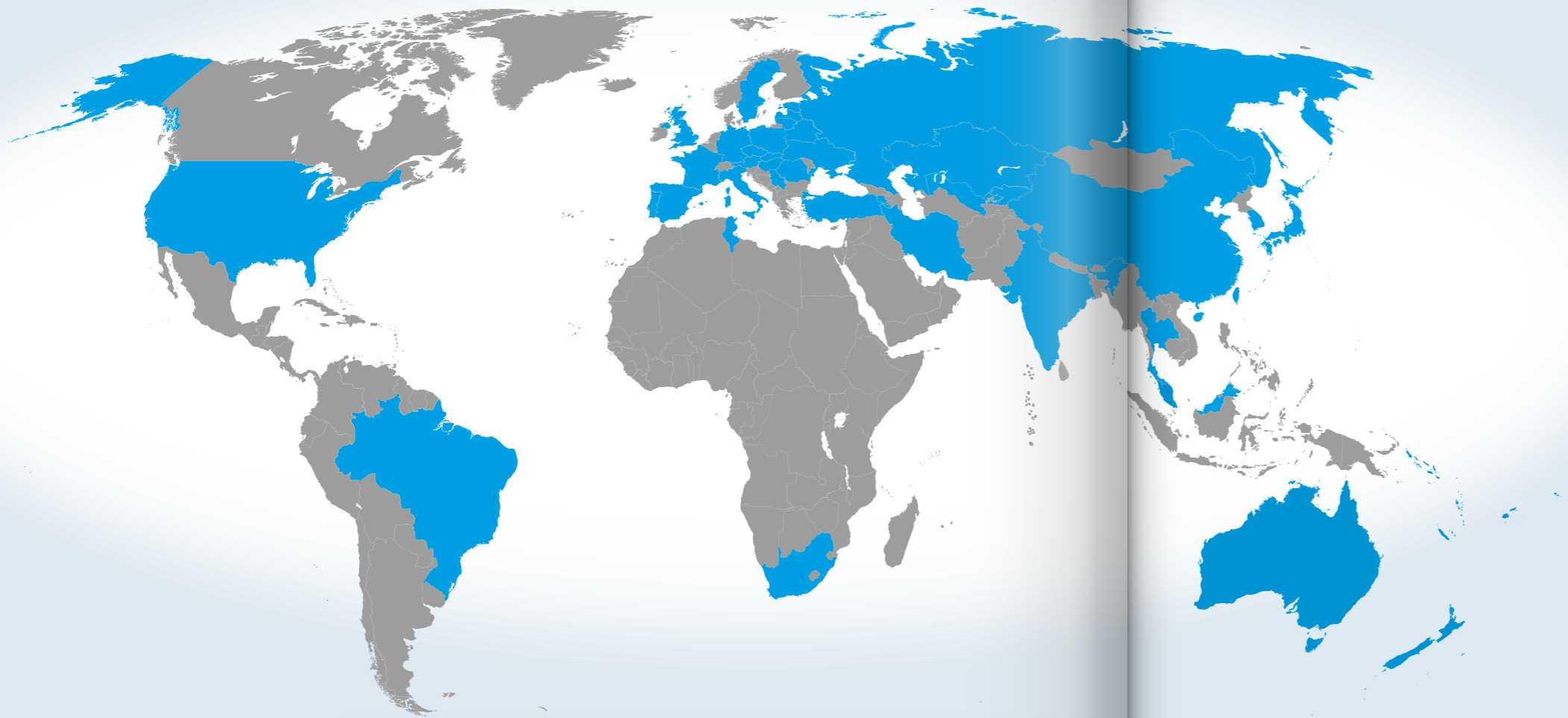

## The company **HÜBNER** worldwide

Think globally, act locally: HÜBNER is there where its customers are – because close contact helps us to understand business partners better and to provide better support. Individual wishes and requirements can be determined quickly and then put into effect and implemented without delay. Customers thus have direct benefits from our strong local presence.

In addition to the company headquarters in Kassel, Germany in the heart of Europe, HÜBNER has built up more than 30 locations around the world in the preceding years and decades. The company now has major plants in Hungary, Poland, the USA, China, Russia and Brazil. This network of company-owned locations is supported by sales partners and trade representatives in more than 30 additional countries.

And the company's offering to customers does not end with the delivery of the products. The HÜBNER Group is also continually expanding its service structures – in personnel and in the technical facilities that are provided. To be on hand ready to provide support as quickly as possible – in locations around the world.

[www.hubner-group.com/en/worldwide](http://www.hubner-group.com/en/worldwide)

<b>1 group</b> with more than <b>30 locations</b>	sales partners & representatives in more than <b>30 countries</b>	approx. <b>3,500</b> employees
	founded in <b>1946</b>	approx. <b>1,000</b> patents worldwide



[www.hubner-group.com](http://www.hubner-group.com)





**HÜBNER GmbH & Co. KG**

Heinrich-Hertz-Straße 2  
34123 Kassel

Tel. +49 561 998-0

Fax +49 561 998-1515

[info@hubner-group.com](mailto:info@hubner-group.com)

[www.hubner-group.com](http://www.hubner-group.com)